

DCP551 Digital Control Programmer

57-77-03-16
January 2009
Page 1 of 12

Specification and Model Selection Guide

Introduction

The DCP551 is a high-function programmer/controller supporting up to 99 program patterns to which thermocouple, resistance temperature detector (RTD), DC voltage, DC current and other signals can be input.

The DCP551 supports: 16 event outputs, 16 external switch inputs and a wide range of other functions as part of the standard specification; and communications and auxiliary output as option functions.

- *Accuracy of ± 0.1 % FS. Easy-to-view large display characters. Compact design*
- *2 PV input type also available*
- *Any input type can be selected by console key operation. Easy operation aided by guidance messages*
- *Up to 99 program patterns can be stored and up to 99 segments can be programmed to each pattern.*
- *Various events can be selected and set for the 16 event outputs, and code events comprising a combination of two or more points can be set.*
- *16 external switch inputs allow the control of remote selection of program Nos. or operation.*
- *CE marking-compatible*
Applicable standards: EN61010- 1



Figure 1—DCP551 – Digital Control Programmer

BASIC FUNCTION BLOCKS of DCP551

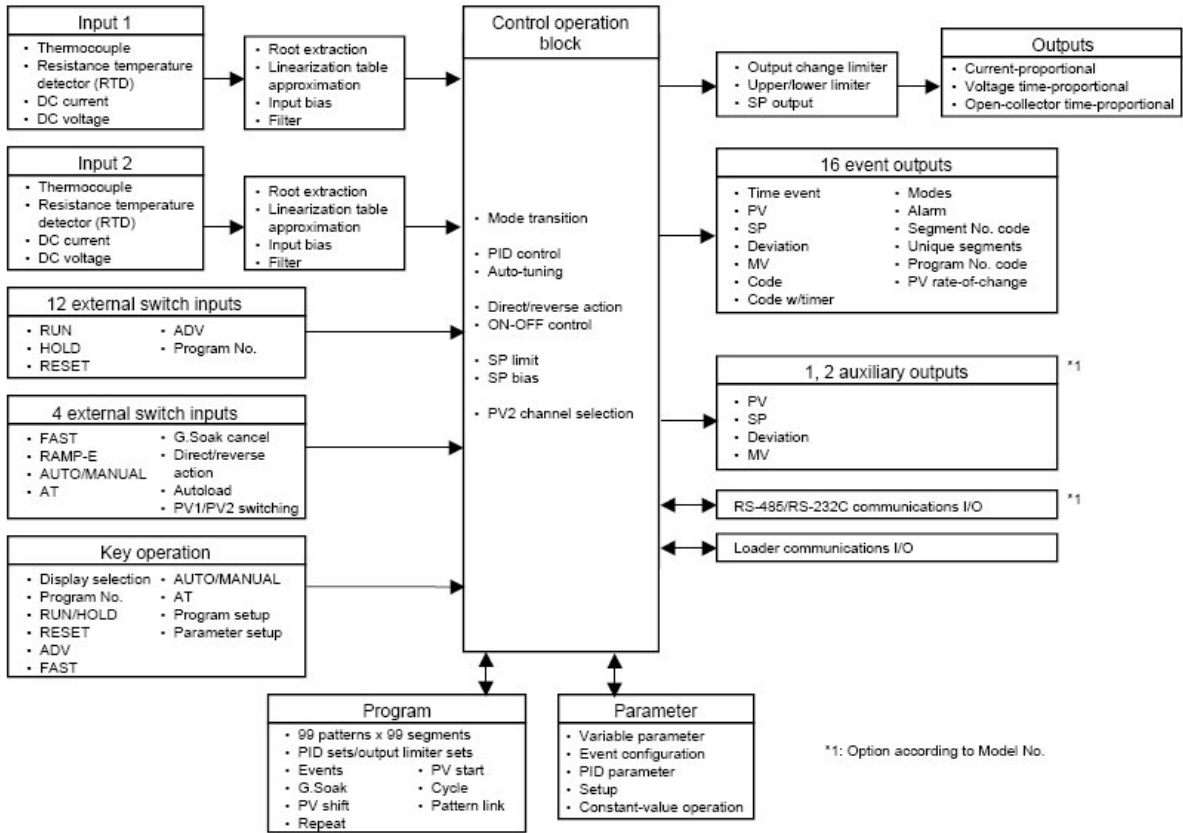

Specifications

Program	Number of programs	99
	Number of segments	99 per program, 2000 per controller
	Segment setting system	RAMP-X: Set by set points (SP) and time. RAMP-T: Set by set points (SP) and ramp (⊖) RAMP-E Set by set points (SP) and Δ SP per external switch input 1
	Segment time	0 to 500 hours 0 minute, 0 to 500 minutes 0 second, 0.0 to 3000.0 seconds (time unit selectable)
	Segment ramp	1 to 10000 U/hour, 1 to 10000 U/minute, 1 to 10000 U/second (time unit selectable)
	Segment ΔSP	1 to 10000 U/l pulse
	Number of sub-functions	4000 settings per controller
	Sub-function action	Events, PID set, output limiter set, G, Soak, PV shift, repeat
	Events (16)	Set operating point corresponding to event type
	PID set No.	Set 0 (continuation of previous segment), 1 to 9, A set (automatically switched) and ON-OFF control
	Output limiter set	Set 0 (continuation of previous segment), 1 to 9
	G.Soak	Set type (start/end points and overall) and G.Soak width 0 to 1000 U.
	PV shift	-10000 to +1 0000 U
	Repeat	Set return destination segment No. and repeat count.
	PV start	Set type (rising/falling or both) for each program.
	Cycle	Set cycle count for each program.
	Pattern link	Set program No. 0 to 99 (0: no link) for each program.
Tag	Set 8 alpha-numeric's or symbols for each program.	
Basic time accuracy	± 0.01 % (segment time setting = 0, with 0.1 second delay for each repeat and cycle)	
Inputs	Input type	Thermocouple, resistance temperature detector (RTD), DC voltage, DC current multi-range (See pages 6, 7.)
	Sampling cycle	0.1 seconds
	Input bias current	Thermocouple~DC voltage input: Max. $\pm 1.3 \mu\text{A}$ (at peak value and reference conditions) 1 V or higher range: Max. $-3 \mu\text{A}$
	Input impedance	DC current input: approx. 50 ohms (under operating conditions)
	Measuring current	RTD input: Approx. 1 mA current flow from terminal A (under operating conditions)
	Influence of wiring resistance	Thermocouple, DC voltage input: Thermocouple: 0.5 $\mu\text{V}/\text{ohm}$ DC voltage (max. 1 V range): 0.5 $\mu\text{V}/\text{ohm}$ DC voltage (5 V range): 3 $\mu\text{V}/\text{ohm}$ DC voltage (10 V range): 6 $\mu\text{V}/\text{ohm}$ RTD input: Max. $\pm 0.01\%$ FS/ohm in wiring resistance range 0 to 10 ohm Range of F01, F33, P01 and P33: $\pm 0.02\%$ FS/ohm max.
	RTD input allowable wiring resistance	Ranges other than F01, F33, P01 and P33: 65 ohms max. (including Zener barrier resistance. Note that site adjustment is required.) Ranges of F01, F33, P01 and P33: 10 ohms max. (Zener barrier cannot be used.)
	Allowable parallel resistance	Thermocouple disconnection detection allowable parallel resistance: 1 Mohm min.
	Max. allowable input	Thermocouple, DC voltage input: -5 to +15V dc DC current input: 50 mA dc, 2.5V dc
	Burnout	Detection selectable
	Over-range detection threshold	110% FS min.: Upscaled -10% FS max.: Downscaled (Note that F50 range is not downscaled.)
Cold-junction compensation accuracy	$\pm 0.50^\circ\text{C}$ (under standard conditions)	
Cold-junction compensation system	Internal/external (0°C only) compensation selectable	

Inputs	Scaling	-19999 to +20000 U (possible in case of linear input only. Inverse scaling possible. Decimal point position settable at any point)
	Square root extraction	Possible. Dropout: 0.2 to 10.0% in case of DC current or DC voltage range
	PV equalizer (linearization table approximation)	PV1: 9 segments (10 points set) PV2: 19 segments (20 points set)
	Input bias	-1000 to +1000 U variable
	Digital filter	0.0 to 120.0 seconds variable (0.0: filter OFF)
External switch inputs	Number of Inputs	16
	Types of connectable outputs	Dry contacts (relay contact) and open-collector (current sink to ground)
	Terminal voltage (open)	8.5 V \pm 0.5 V between common terminals (terminals 12, 40) and each input terminal (under operating conditions)
	Terminal current (short-circuit)	Approx. 6 mA between each terminal (under operating conditions)
	Allowable contact resistance (dry contact)	ON: 250 Ω max. (under operating conditions) OFF: 100 k Ω min. (under operating conditions)
	Voltage drop (at open-collector ON)	2 V max. (under operating conditions)
	Leakage current (at open-collector OFF)	0.1 mA max. (under operating conditions)
	Assignments (fixed)	RUN, HOLD, RESET, ADV, program No.
	Assignments (variable)	RAMP-E, FAST, AT, AUTO/MANUAL, G.Soak cancel, direct/reverse action, auto-load, PV1/2 switching
	Input sampling cycle	0.1 seconds
	ON detection min. hold time	0.2 seconds (0.4 seconds for program No.)
Indication/Programmer	Upper display	Green 5-digit, 7-segment LED This displays PV values in the basic display state. Item codes are displayed in the parameter setup.
	Lower display	Orange 5-digit, 7-segment LED This displays SP and output % in the basic display state. Setting values are displayed in the parameter setup.
	Program No. display	Green 2-digit, 7-segment LED This displays program No. in the basic display state.
	Segment No. display	Green 2-digit, 7-segment LED This displays segment No. in the basic display state. Item Nos. are displayed in parameter setup, and alarm No. is displayed when alarm occurs.
	Message display	This displays output graph, deviation graph, event state and tags in the basic display state. This displays reference messages in the parameter setup and program setup. This displays operation details and operation results of memory card operation.
	Profile display	7 orange LEDs Displays program pattern rise, soak and fall trends.
	Status displays	22 round LEDs Modes: RUN, HLD, MAN, PRG (green) Display details: PV, SP, OUT, TM, CYC, SYN, DEV (green) Battery voltage: BAT (red) (blinks at low voltage) Status: AT (green) Events: EG1, EG2 (red)
	Operation keys	16 rubber keys
	Loader connector port	1 (dedicated cable with stereo miniplugs)

Modes	Program operation modes	READY: Ready to run program (control stop/program No. selectable)	
		RUN: Program run	
	Constant-value operation modes	HOLD: Program hold	
		FAST: Program fast-forward	
Controller	PID controls	END: Program end	
		READY FAST: Ready to run and fast-forward program	
		AUTO: Automatic operation	
		MANUAL: Manual operation (output can be controlled on console)	
		Proportional band (P)	0.0 to 1000.0% (0.0: ON-OFF control)
	Reset time (I)	0 to 3600 seconds. 0 seconds: PD control	
	Rate time (D)	0 to 1200 seconds. 0 seconds: PI control	
	MV limit	Lower limit: -5.0 to upper limit % Upper limit: Lower limit to +105.0%	
	Manual reset	0.0 to 100.0%	
	PID controls	Number of PID sets	16 sets for program operation (9 segment unique sets+ 7 sets for automatic zone selection)
		PID set selection	Segment designation/automatic zone selection can be switched by program operation.
		MV change	0.1 to 110.0%/0.1 seconds
		Auto-tuning	Automatic setting of PID value by limit cycle system
		ON-OFF control differential	0 to 1000 U
Direct/reverse actionswitching	Possible		
Programmer function	Switching	MV output switchable to SP output	
	Scaling	Possible	
	Output resolution	1/1 0000	
Outputs	Auxiliary output	Output types	PV, SP, deviation, MV, PV1, PV2
		Scaling	Possible
	Current output (5G) auxiliary outputs CH1, CH2	Output current:	4 to 20 mA dc
		Allowable load resistance:	600 Ω max. (under operating conditions)
	Voltage output (6D)	Output accuracy:	±0.1 % FS max. (under standard conditions)
		Output resolution:	1/1 0000
		Max. output current	21.6 mA dc
		Min. output current	2.4 mA dc
Output updating cycle:		0.1 seconds	
Open terminal voltage:		25 V max.	
Allowable load resistance:		600 Ω max. (under operating conditions)	
Load current adjustment:	2 to 22 mA variable		
Variable open terminal voltage:	25 V max.		
OFF leakage current	100 μA max.		
Output response time:	At ON-OFF 600 Ω load: 0.5 ms max. At OFF-ON 600 Ω load: 0.5 ms max.		
Output resolution:	1/1000		
Time-proportional cycle:	1 to 240 seconds variable		
Open-collector output (8D)	External supply voltage:	12 to 24V dc	
	Max. load current:	100 mA/load	
	OFF leakage current	0.1 mA max.	
	ON residual voltage:	2 V max.	
	Output resolution:	1/1000	
Open-collector output	Time-proportional cycle:	1 to 240 seconds variable	
	External supply voltage:	12 to 24V dc	
	Max. load current:	70 mA/load	
	Max. common current:	500 mA	
	OFF leakage current:	0.1 mA max.	
ON residual voltage:	2 V max.		

Event outputs	Event types	PV type	PV, deviation, w/ deviation standby, absolute value deviation, w/absolute value deviation standby, PV rate-of-change, SP, MV, G.Soak absolute value deviation w/ G.Soak absolute value deviation standby, PV1 constant operation, PV2 constant operation, difference between PV1-PV2 at channel switching, difference between PV1-PV2
		Time type	Time events, RAMP-E time monitor, segment time, program time
		Code type	Code event, code event w/ timer, program No. binary code, segment No. binary code, program No. BCD code, segment No. BCD code
		Mode type	Unique segment, RUN+ HOLD+ END+ FAST, HOLD, READY+READY FAST, END, G.Soak standby, MANUAL, AT executing, FAST+READY FAST, console operation in progress, RUN, advance, all alarms, PV range alarm, controller alarm, PV1 currently selected, PV2 currently selected, low battery voltage
	Event Hysteresis	In case of PV type set, 0 to 1000 U	
Event ON delay	0.0 to 3000.0 can be set to four events		
Communications	RS-485	Network	Multidrop This controller is provided with only slave instrument functionality. 1 to 16 units max. (DIM) 1 to 31 units max. (CMA, SCM)
		Data flow	Half duplex
		Synchronization	Start-stop synchronization
		Transmission system	Balanced (differential)
		Data line	Bit serial
		Signal line	5 transmit/receive lines (3-wire connection also possible)
	RS-485	Transmission speed	1200, 2400, 4800, 9600 bps
		Transmission distance	500 m max. (total) (300 m max. for MA500 DIM connection)
		Other	Conforming to RS-485 interface specifications
		Char. bit count	11 bits/character
		Format	1 start bit, even parity, 1 stop bit; or 1 start bit, no parity, and 2 stop bits
		Data length	8 bits
		Isolation	All inputs and outputs are completely isolated except external switch inputs.
	RS-485 communications can be performed by connecting to a computer equipped with an RS-485 interface		
	RS-232C	Network	1:1 Connected, This controller is provided with only slave instrument functionality.
		Data flow	Half duplex
		Synchronization	Start-stop synchronization
		Transmission system	Unbalanced type
		Data line	Bit serial
		Signal line	3 transmit/receive lines
		Transmission speed	1200, 2400, 4800, 9600 bps
		Transmission distance	15 m max.
		Other	Conforming to RS-232C interface specifications
	Char. bit count	11 bits/character	
	Format	1 start bit, even parity, 1 stop bit; or 1 start bit, no parity, and 2 stop bits	
	Data length	8 bits	
	Isolation	All inputs and outputs are completely isolated except external switch inputs.	

General Specifications	Memory backup	Memory Battery life	Battery backed up RAM Controller power OFF: Approx. 5 years under standard conditions Controller power ON: Approx. 10 years under standard Conditions				
	Rated power voltage	100 to 240V ac, 50/60 Hz					
	Power consumption	25 VA max.					
	Power ON rush current	50A max.					
	Power ON operation	Reset time: 10 seconds max. (time until normal operation is possible under normal operating conditions).					
	Allowable transient power loss	20 ms max. (under operating conditions)					
	Insulation resistance	Min. 50MΩ across power terminal 39 or 40 and FG terminal 52 or 53 (by 500V dc megger)					
Dielectric strength	1500V ac 50/60 Hz for 1 minute between power terminal and FG terminal Note) The primary side and secondary side capacities are joined inside the product. For this reason, when carrying out a withstand voltage test, disconnect the wiring of the grounded secondary side terminals (e.g. when grounding type thermocouple is used) from that terminal. If the test is carried out with the wiring as it is, this might result in malfunction.						
General Specifications	Standard conditions	Ambient temperature	23 ±2°C				
		Ambient humidity	60±5%RH				
		Rated power voltage	105V ac±1%				
		Power frequency	50±1Hz. Or 60+/-1Hz				
		Vibration resistance	0 m/s ²				
		Shock resistance	0 m/s ²				
		Mounting angle	Reference plane (vertical) ±3				
	Operating conditions	Ambient temperature	0 to 50°C (ambient temperature at the bottom side of case when gang mounted)				
		Ambient humidity range	10 to 90%RH (condensation not allowed)				
		Rated power voltage	100 to 240V ac				
		Allowable power voltage	90 to 264V ac				
		Power frequency	50±2 Hz, or 60±2Hz				
		Vibration resistance	0 to 1.96 m/s ²				
		Shock resistance	0 to 9.80 m/s ²				
		Mounting angle	Reference plane (vertical) ±10°				
	Transport/storage conditions	Ambient temperature range	-20 to +70 °C				
		Ambient humidity range	10 to 95%RH (condensation not allowed)				
		Vibration resistance	0 to 4.90 m/s ² (10 to 60 Hz for 2 hours each in X, Y and Z directions)				
		Shock resistance	0 to 490 m/s ² (3 times vertically)				
		Package drop test	Drop height: 60 cm (1 angle, 3 edges and 6 planes; free fall)				
		Terminal screw	M3.5 self-tapping screws				
	Terminal screw Tightening torque	0.78 to 0.98 Nm					
	Mask/case materials	Mask: Multilon Case: Multilon					
	Mask/case color	Mask: Dark gray (Munsell 5Y3.5/1), Case: Light gray (Munsell 2.5Y7.5/1)					
	Installation	Specially designed mounting bracket					
	Weight	1.5 kg					
Standard accessories	Item	Model No.	Q'ty	Auxiliary parts (sold separately)	Item	Model No.	Q'ty
	Unit indicating label	—	1		Soft dust-proof cover set	81446141-001	
	Mounting bracket	81446044-001	1 set (2 pieces)		Lithium battery set	81446140-001	Approx.200 g
	User's Manual	CP-UM-5005E	1				

Input Types and Ranges (selectable in setup)

• Thermocouple

Input Type		Range No.	Input Range		Accuracy (under standard conditions)	
Symbol	Code		°C	(FS) °F		
K (CA)	K46	16	-200.0 to +200.0	-300.0 to +400.0	±0.1 % FS	
K (CA)	K09	0	0.0 to 1200.0	0 to 2400	±0.1 % FS	
K (CA)	K08	1	0.0 to 800.0	0 to 1600	±0.1 % FS	
K (CA)	K04	2	0.0 to 400.0	0 to 750	±0.1 % FS	
E (CRC)	E08	3	0.0 to 800.0	0 to 1800	±0.1 % FS	
J (IC)	J08	4	0.0 to 800.0	0.0 to 1600	±0.1% FS	
T (CC)	T44	5	-200.0 to +300.0	-300 to +700	±0.1% FS	±0.3% FS between -200°C WR -45°C
B (PR30-6)	B18	6	0.0 to 1800.0	0 to 3300	±0.1% FS	±4.0% FS between 0 to 260°C ± 0.15% FS between 260 to 800°C
R (PR13)	R16	7	0.0 to 1600.0	0 to 3100	±0.1% FS	
S (PR10)	S16	8	0.0 to 1600.0	0 to 3100	±0.1% FS	
W (WRe5-26)	W23	9	0.0 to 2300.0	0 to 4200	±0.1% FS	
W (WRe5-26)	W14	10	0.0 to 1400.0	0 to 2552	±0.1% FS	
PR40-20	D19	11	0.0 to 1900.0	0 to 3400	±0.2% FS	±0.9% FS between 0 to 300°C ± 5% FS between 300 to 800°C
N	U13	12	0.0 to 1300.0	32 to 2372	±0.1% FS	
PLII	Y13	13	0.0 to 1300.0	32 to 2372	±0.1% FS	
Ni-Ni-Mo	Z13	14	0.0 to 1300.0	32 to 2372	±0.1% FS	
Golden iron chromel	Z06	15	0.0 to 300.0 K (K = Kelvin)		±0.4% FS	

• Resistance temperature detector (RTD)

Input Type			Input Range (FS)		Accuracy (under standard conditions)	
Symbol	Code	Range No.	°C	°F		
JIS'89Pt100 (IEC Pt100 Ω)	F50	64	-200.0 to +500.0	-300.0 to +900.0	±0.1% FS	
	F46	65	-200.0 to +200.0	-300.0 to +400.0	±0.1% FS	
	F32	66	-100 to +150.0	-150.0 to +300.0	±0.1 % FS	
	F36	67	-50.0 to +200.0	-50.0 to +400.0	±0.1 % FS	
	F33	68	-40.0 to +60.0	-40.0 to +140.0	±0.15% FS	
	F01	69	0.0 to 100.0	0.0 to 200.0	±0.15% FS	
	F03	70	0.0 to 300.0	0.0 to 500.0	±0.1% FS	
	F05	71	0.0 to 500.0	0.0 to 900.0	±0.1% FS	
JIS'89JPt100	P50	96	-200.0 to +500.0	-300.0 to +900.0	±0.1% FS	
	P46	97	-200.0 to +200.0	-300.0 to +400.0	±0.1 % FS	
	P32	98	-100.0 to +150.0	-150.0 to +300.0	±0.1 % FS	
	P36	99	-50.0 to +200.0	-50.0 to +400.0	±0.1 % FS	
	P33	100	-40.0 to +60.0	-40.0 to +140.0	±0.15% FS	
	P01	101	0.0 to 100.0	0.0 to 200.0	±0.15% FS	
	P03	102	0.0 to 300.0	0.0 to 500.0	±0.1 % FS	
	P05	103	0.0 to 500.0	0.0 to 900.0	±0.1 % FS	

DC Current, DC Voltage

Input Type			Input Range (FS)		Accuracy (under standard conditions)		
Symbol	Code	Range No.					
mA (linear)	Col	48	4 to 20 mA	Programmable range -19999 to +20000 (decimal point position can be changed)	+/-0.1%FS		
	Z51	52	2.4 to 20 mA		+/-0.1%FS		
mV	MO1	49	0 to 10 mV		+/-0.1%FS		
	L02	50	-10 to 10 mV		+/-0.1%FS		
		51	0 to 100 mV		+/-0.15%FS		
mA (linear)	CO1	128	4 to 20 mA		Programmable range -19999 to +20000 (decimal point position can be changed)	+/-0.15%FS	
	Z51	124	2.4 to 20 mA			+/-0.1%FS	
V (linear)		129	0 to 1V			+/-0.1%FS	
		130	-1 to +1V			+/-0.1%FS	
	Vol	131	1 to 5V			+/-0.1%FS	
		132	0 to 5V	+/-0.1%FS			
		133	0 to 10V	+/-0.1%FS			
						+/-0.1%FS	

Handling Precautions

- The unit of code Z06 is Kelvin (K).
- The PV lower limit alarm does not occur with codes F50 and P50.
- The number of digits past the decimal point for DC current and DC voltage is programmable within the range 0 to 4.

Model Selection Guide

I Basic Model No.	II —	III Number of PV inputs	IV Appended No.	V Option	VI Additions	Specifications	
DCP551	F					Digital Programmable Controller (single-loop model)	
						Universal Output	
		1				One Input	
		2				Two Inputs	
				0			No Selection
					0		None
					1		1 Auxiliary Output
					2		2 Auxiliary Outputs
						00	None

External Dimensions & Panel Cut-Out

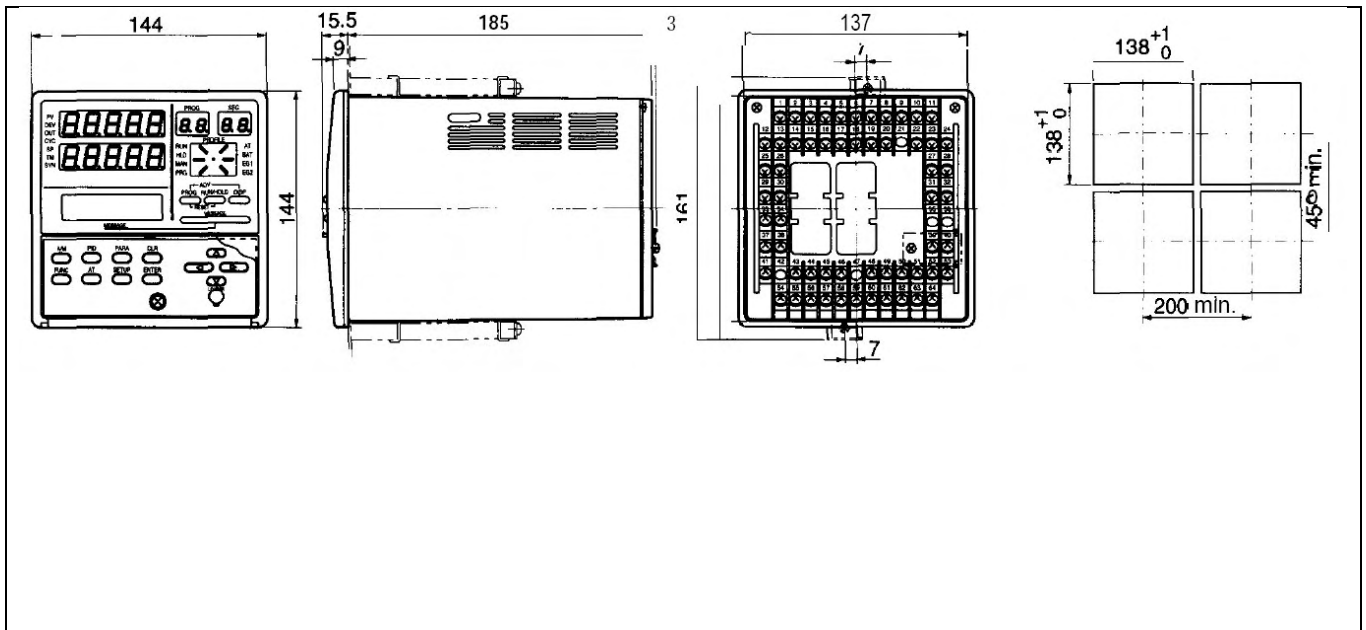

WIRING

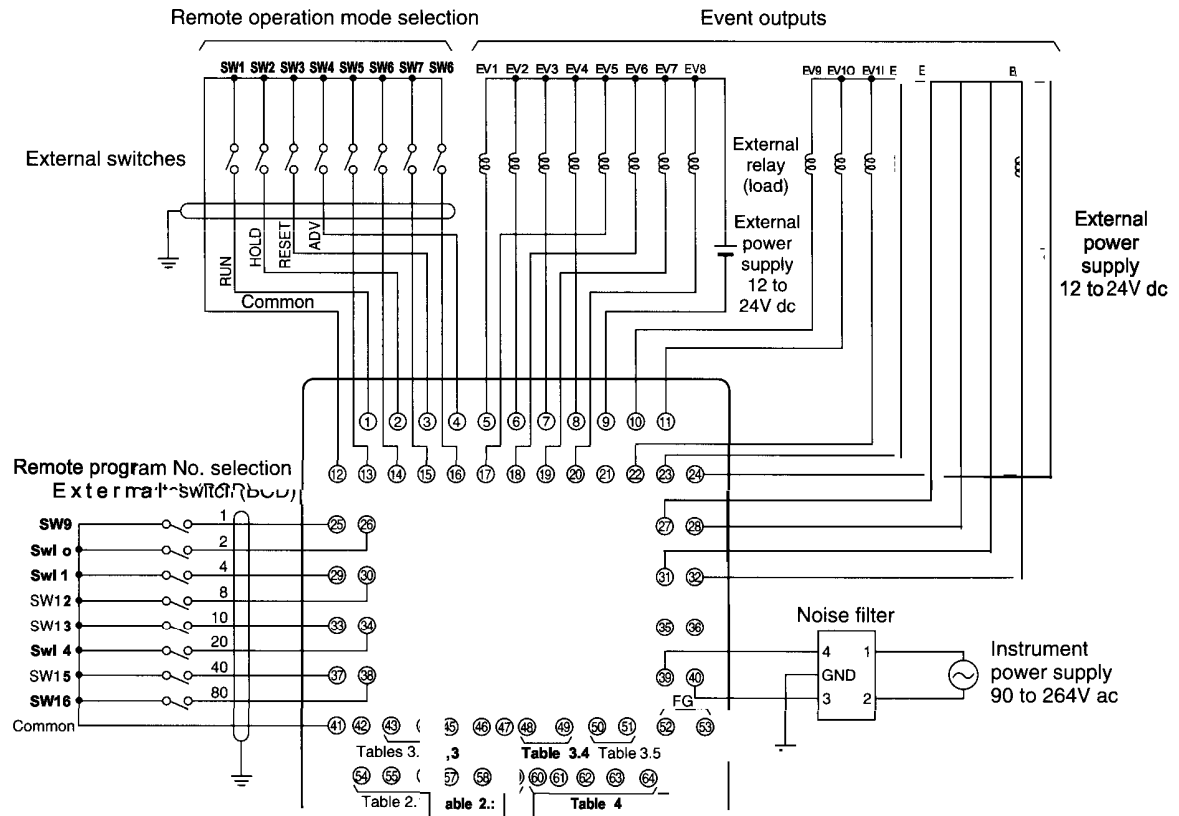

Table 2 PV Input

1. ch 1			
Thermocouple	Resistance temperature detector (RTD)	Voltage (mV/V)	Current (mA)
2. ch 2			
Thermocouple	Resistance temperature detector (RTD)	Voltage (mV/V)	Current (mA)

Table 3 Control, Setup and Auxiliary Output

1. Transistor Open Collector	2. Voltage	3. Current
Control output	Control output	Control output/ Setup output
4. Current	5. Current	
Auxiliary output CH1	Auxiliary output CH2	

Continued on following page

Wiring Continued

Continued from previous page

Table 4 Communications I/O

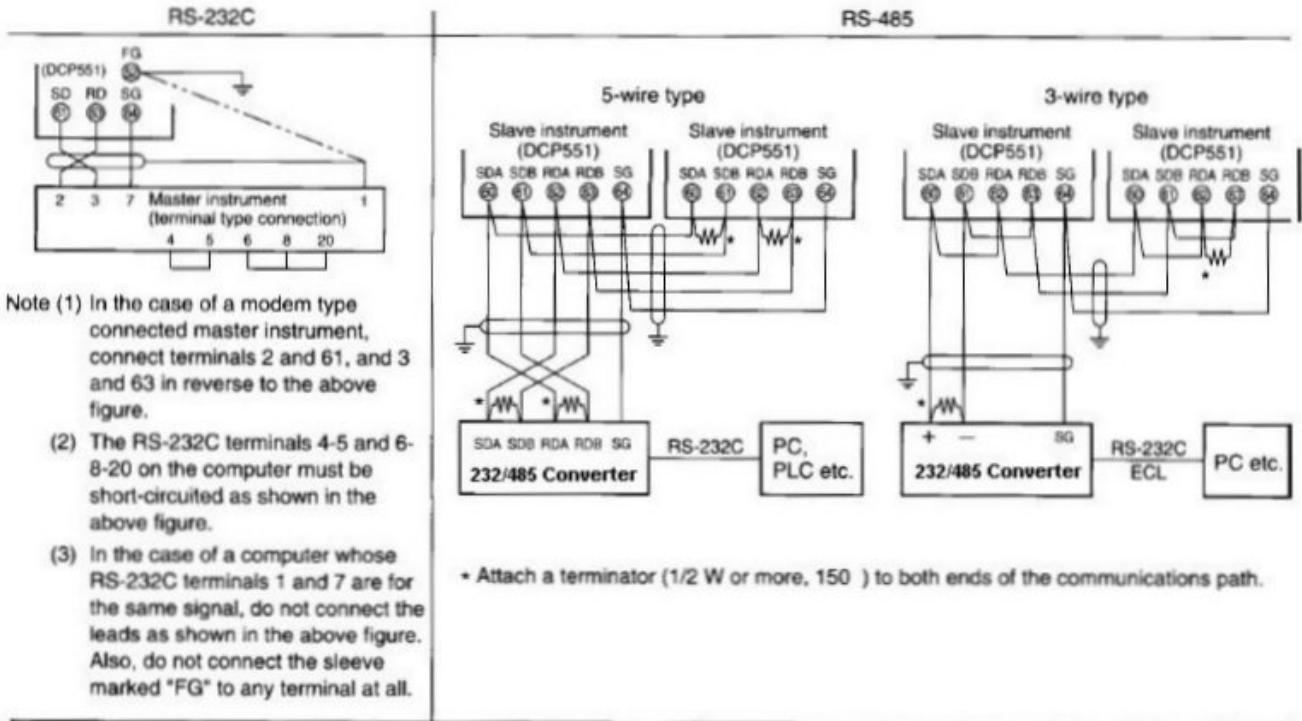

WIRING PRECAUTIONS

1. Isolating Inputs and Outputs inside the Controller

Solid lines — show isolated items,
Dotted lines ----show non-isolated

PV input CH1	Digital circuit	Control output
PV input CH2		Auxilliary output CH1
Loader communications		Auxilliary output CH2
External switch input Communications		Event Output

2. Noise Countermeasures for Instrument Power Supplies

(1) Reducing noise

Connect the DCP551 to a single-phase power supply for instruments, and take measures to the influence of electrical noise.

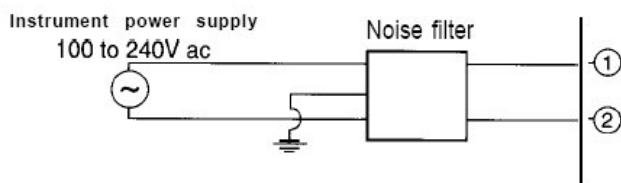

(2) When there is a lot of noise

If there is a lot of electrical noise, we recommend inserting an insulation transformer in the power circuit and using a line filter.

Instrument power supply 100 to 240V ac
Insulating Transformer (100/100 v, 200/200 V)
Line filter

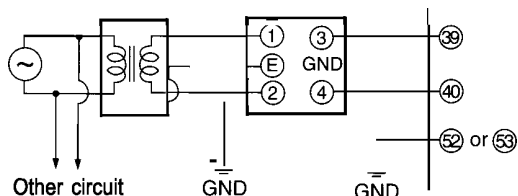

3. Noise Generating Sources and Countermeasures

Generally, the following generate electrical noise:

Relays and contacts, electromagnetic coils, solenoid valves, power lines (in particular, 90V ac min.), induction loads, inverters, motor commutators, phase angle control SCR radio communications equipment, welding equipment, high-voltage ignition equipment.

(1) Fast-rising noise

CR filters are effective in countering fast-rising noise.

(2) Noise with a high wave height

Varistors are effective in countering noise with a high wave height. However, note that the varistor may become circuited when trouble occurs. Pay attention to this when providing a varistor on a controller.

4. Ground

Use only the FG terminal 52 or 53 on the DCP551 for grounding. Do not ground across other terminals. When it is difficult to ground shielded cable, prepare a separate GND terminal plate (earth bar).

Ground type: 100 Ω max.
Ground cable: 2 mm² min. annealed-copper wire (AWG14)
Cable length: Max. 20 m

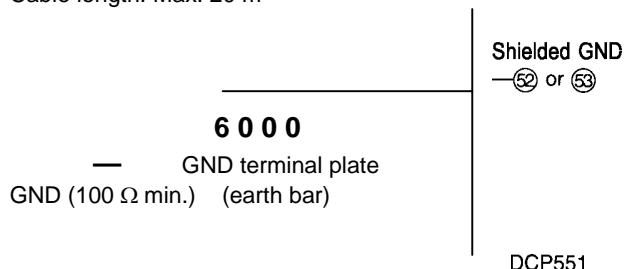

5. Precautions during Wiring

- (1) After providing anti-noise measures, do not bundle primary and secondary power leads together, or pass them through the same piping or wiring duct.
- (2) Maintain a distance of at least 50 cm between I/O signal leads or communications leads and the power lead. Also, do not pass these leads through the same piping or wiring duct.

6. Inspection after Wiring

After wiring is completed, be sure to inspect and check the wiring state. Wrong wiring may cause controller malfunction or accidents.

Honeywell

Honeywell Field Solutions

2500 W. Union Hill Drive
Phoenix, Arizona 85027
Tel: 877.466.3993 or 602.313.6665

www.honeywell.com/ps

57-77-03-16
January 2009
© 2009 Honeywell International Inc.
